

# 10 1/2'''

ETA 255.481  
 255.483  
 255.485  
 255.487

COMMUNICATION  
 TECHNIQUE

TECHNISCHE  
 MITTEILUNG

TECHNICAL  
 COMMUNICATION

<p>10 1/2'''</p> <p>Ø 23.30 mm</p>				
<p>HAUTEUR          HÖHE          HEIGHT</p> <p>mm</p>	<p>sur mouvement          auf Uhrwerk          on movement</p>		<p>2,70</p>	
	<p>sur pile          auf Batterie          on battery</p>		<p>2,85</p>	
	<p><b>255.481</b></p> <p>Petite seconde          Kleine Sekunde          Small second</p>	<p><b>255.485</b></p> <p>SC</p>	<p><b>255.483</b></p> <p>Petite seconde          Kleine Sekunde          Small second</p>	<p><b>255.487</b></p> <p>SC</p>

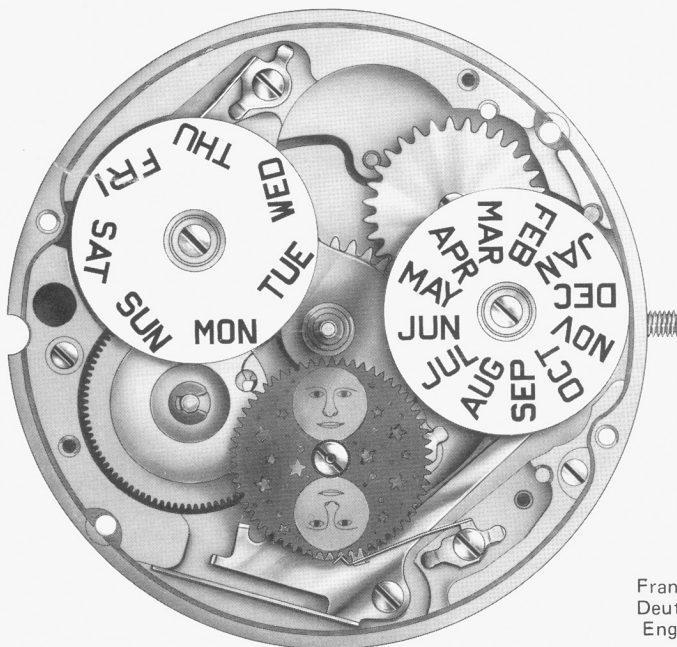

255.481



255.487

















































Français  
 Deutsch  
 English













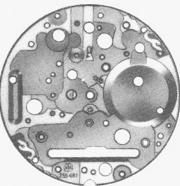



INTERCHANGEABILITE — AUSWECHSELBARKEIT — INTERCHANGEABILITY

No Nr No	No Nr ISO No	LISTE DES FOURNITURES	BESTANDTEILE	LIST OF MATERIALS	Cal. — Kal. — Cal.			
					255.481	255.483	255.485	255.487
100	20.020.07	Platine, empierrée	Werkplatte, mit Steinen	Main plate, jewelled	255.481	255.481	255.485	255.485
110	10.048.07	Pont de rouage, empierré	Räderwerkbrücke, mit Steinen	Train wheel bridge, jewelled	255.491	255.491	255.111	255.111
144	10.300	Fixateur de cadran	Zifferblatthalter	Dial fastener	950.001	950.001	950.001	950.001
145	10.106	Support de cadran	Träger für Zifferblatt	Dial support	255.481	255.481	255.481	255.481
161	80.400	Tube de centre	Zentrumlagerrohr	Centre tube	255.121	255.121	255.121	255.121
203	30.012	Roue intermédiaire	Zwischenrad	Intermediate wheel	255.111	255.111	255.111	255.111
210	30.025	Roue moyenne	Kleinbodenrad	Third-wheel	255.491	255.491	255.111	255.111
215	30.029	Roue intermédiaire de seconde	Zwischen-Sekundenrad	Intermediate second wheel	255.491	255.491	—	—
224	30.027.13	Roue de seconde, long pivot dessous	Sekundenrad, mit langem Zapfen unten	Second wheel, with long lower pivot	255.481	255.481	—	—
227	30.027	Roue de seconde	Sekundenrad	Second wheel	—	—	255.485	255.485
227/3	30.027.18	Roue de seconde, sans seconde au centre	Sekundenrad, ohne Zentralsekunde	Second wheel, without sweep wheel	255.491	255.491	—	—
242	31.083	Chaussée avec entraîneur	Minutenrohr mit Mitnehmer	Cannon pinion with driver	—	—	255.485	255.485
242/1	31.083.18	Chaussée avec entraîneur, sans seconde au centre	Minutenrohr mit Mitnehmer, ohne Zentralsekunde	Cannon pinion with driver, without sweep second	255.481	255.481	—	—
250	31.046	Roue des heures	Stundenrad	Hour wheel	255.481	255.481	255.481	255.481
260	31.041	Roue de minuterie	Wechselrad	Minute wheel	255.111	255.111	255.111	255.111
405	51.020.21	Tige de mise à l'heure, Ø de filetage 0.90 mm	Stellwelle, Gewindedurchmesser Ø 0.90 mm	Hand setting stem, thread diameter 0.90 mm	255.111	255.111	255.111	255.111
405/4	51.020.26	Tige de mise à l'heure, partie mouvement à bec	Stellwelle, Werkteil mit Zunge	Handsetting stem, movement part with beak	255.411	255.411	255.411	255.411
407	31.121	Pignon coulant	Kupplungstrieb	Sliding pinion	255.111	255.111	255.111	255.111
435/1	51.050.06	Bascule de pignon coulant, montée	Kupplungstriebhebel, montiert	Yoke, assembled	255.111	255.111	255.111	255.111
443/1	51.080.06	Tirette, montée	Winkelhebel, montiert	Setting lever, assembled	255.111	255.111	255.111	255.111
445	51.090	Sautoir de tirette	Winkelhebelraste	Setting lever jumper	255.111	255.111	255.111	255.111
450	31.100	Renvoi	Zeigerstellrad	Setting wheel	255.111	255.111	255.111	255.111
462	10.062	Pont du rouage de minuterie	Wechselradbrücke	Minute train bridge	255.481	255.481	255.481	255.481
466	10.210	Couvre-mécanisme	Deckplatte für Stelleinrichtung	Setting mechanism cover	255.111	255.111	255.111	255.111
479	61.090	Ressort de tirette	Winkelhebelfeder	Setting lever spring	255.111	255.111	255.111	255.111
560	56.071	Levier d'arrêt et interrupteur	Stopphebel und Unterbrecher	Stop lever and switch	255.111	255.111	255.111	255.111
2549	33.022	Roue entraîneuse de l'étoile des mois, pour guichet à 12h	Monatsstern-Mitnehmerrad, für Fenster auf 12 Uhr	Month star driving wheel, for window at 12 o'clock	255.481	255.481	255.481	255.481
2549 <sup>1</sup>	33.022.18	Roue entraîneuse de l'étoile des mois, pour guichet à 3h	Monatsstern-Mitnehmerrad, für Fenster auf 3 Uhr	Month star driving wheel, for window at 3 o'clock	255.481	—	255.481	—
2555	33.028	Roue entraîneuse du calendrier	Kalendermittel merrad	Calendar driving wheel	255.481	255.481	255.481	255.481
2557	33.120	Etoile de quantième	Datumstern	Date star	255.481	255.481	255.481	255.481
2561	33.121	Etoile des jours	Tagesstern	Day star	—	255.483	—	255.483
2561/1	91.441.41	Indicateur du jour, pour guichet à 12h	Tagesanzeiger, für Fenster auf 12 Uhr	Day indicator, for window at 12 o'clock	255.481	—	255.481	—
2561/1	91.441.42	Indicateur du jour, pour guichet à 3h	Tagesanzeiger, für Fenster auf 3 Uhr	Day indicator, for window at 3 o'clock	255.481	—	255.481	—
2562	33.122	Etoile des mois	Monatsstern	Month star	—	255.483	—	255.483
2562/1	91.443.21	Indicateur du mois, pour guichet à 12h	Monatsanzeiger, für Fenster auf 12 Uhr	Month indicator, for window at 12 o'clock	255.481	—	255.481	—
2562/1	91.443.22	Indicateur du mois, pour guichet à 3h	Monatsanzeiger, für Fenster auf 3 Uhr	Month indicator, for window at 3 o'clock	255.481	—	255.481	—
2569	53.204	Correcteur double	Doppelkorrektor	Double corrector	255.481	255.481	255.481	255.481
2576	53.080	Sautoir de quantième	Datumraste	Date jumper	255.481	255.481	255.481	255.481
2577	53.081	Sautoir des jours	Tagesraste	Day jumper	255.481	255.481	255.481	255.481
2578	53.082	Sautoir des mois	Monatsraste	Month jumper	255.481	255.481	255.481	255.481
2587/1	91.444	Indicateur de phase lunaire	Mondphasenanzeiger	Moon phase indicator	255.481	255.481	255.485	255.485
2588	53.083	Sautoir des phases	Mondphasenraste	Moon phase jumper	255.481	255.481	255.481	255.481
2589	53.044	Bascule des phases	Wippe für Mondphasenanzeige	Moon phase yoke	255.481	255.481	255.485	255.485
2743	33.082	Renvoi intermédiaire du correcteur de quantième	Datumkorrektor-Zwischenverbindungsrad	Date corrector intermediate setting wheel	255.111	255.111	255.111	255.111
2773	63.250	Friction de l'indicateur du jour	Friktionsfeder für Tagesanzeiger	Day indicator friction	—	255.483	—	255.483
2782	83.170	Clavette de roue entraîneuse de calendrier	Klemmscheibe für Kalendermitnehmerrad	Calendar driving wheel spring-clip	255.491	255.491	255.491	255.491



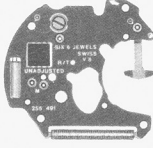



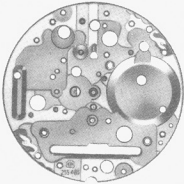

Fournitures communes aux Cal. 255.481 – 255.483  
 Identische Teile für Kal. 255.485 – 255.487  
 Identical parts for Cal.

									
144 10.300	145 10.106	161 80.400	203 30.012	250 31.046	260 31.041	405 51.020.21	405/4 51.021.26	5101 10.020.01	5102 10.020.02
									
407 31.121	435/1 51.050.06	443/1 51.080.06	445 51.090	450 31.100	462 10.062	466 10.210	479 61.090	560 56.071	5110 10.048.01
									
2549 33.022	2555 33.028	2557 33.120	2569 53.204	2576 53.080	2577 53.081	2578 53.082	2588 53.083	2743 33.082	2782 83.170
									
4021 20.582	4038 20.584	4046 20.651	4046 <sup>1</sup> 20.651.18	4211 20.580	4407 20.764	4412 10.601	52576 53.080.01	52589 53.044.01	
									
4929 20.570	9716 66.140	52577 53.081.01	52578 53.082.01	52588 53.083.01	53081.01 53.081.01	53082.01 53.082.01	53083.01 53.083.01	53081.01 53.081.01	





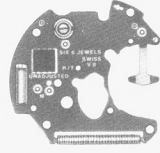

Fournitures communes aux Cal.  
 Identische Teile für Kal. 255.481 – 255.483  
 Identical parts for Cal.

									
100 10.020.07	110 10.048.07	210 30.025	215 30.029	224 30.027.13	227/3 30.027.18	242/1 31.083.18	2587/1 91.444	2589 53.044	52587 91.444.01
									
4000 10.513	53081.01 53.081.01	53082.01 53.082.01	53083.01 53.083.01	53081.01 53.081.01	53082.01 53.082.01	53083.01 53.083.01	53081.01 53.081.01	53082.01 53.082.01	53083.01 53.083.01





Fournitures communes aux Cal.  
 Identische Teile für Kal. 255.485 – 255.487  
 Identical parts for Cal.

								
<b>100</b> 10.020.07	<b>110</b> 10.048.07	<b>210</b> 30.025	<b>227</b> 30.027	<b>242</b> 31.083	<b>2587/1</b> 91.444	<b>2589</b> 53.044	<b>4000</b> 10.513	<b>52587</b> 91.444.01

Fournitures communes aux Cal.  
 Identische Teile für Kal. 255.481 – 255.485  
 Identical parts for Cal.

						
<b>2549<sup>1</sup></b> 33.022.18	<b>2561/1</b> 91.441.41 12 h.	<b>2561/1</b> 91.441.42 3 h.	<b>2562/1</b> 91.443.21 12 h.	<b>2562/1</b> 91.443.22 3 h.	<b>52561</b> 91.441.01	<b>52562<sup>1</sup></b> 91.443.01

Fournitures communes aux Cal.  
 Identische Teile für Kal. 255.483 – 255.487  
 Identical parts for Cal.

				
<b>2561</b> 33.121	<b>2562</b> 33.122	<b>2773</b> 2808	<b>63250</b> 63252	<b>52562</b> 33.122.01







Cal.  
 Kal. 255.481 – 255.483 – 255.485 – 255.487  
 Cal.

145

5145

5145

2782

2555

2557

250

52576

2576

5462

462

450

260

242/1

242

Cal. 255.481  
 255.483

Cal. 255.485  
 255.487

2569



100

**Montage du mécanisme de calendrier.**  
 (Liste des fournitures par ordre d'assemblage).

**Zusammenstellen des Kalender-Mechanismus.**  
 (Bestandteilliste in Montagerihenfolge).

**Assembling of the calendar-mechanism.**  
 (Parts listed in order of assembly).

- 100
- 242/1 (Cal. 255.481/483)
- 242 (Cal. 255.485/487)
- 450
- 260
- 462
- 5462 (1x)
- 2576 (1x)
- 52576 (1x)
- 250
- 2557
- 2555
- 2782
- 145
- 5145 (2x)

- |  |  |            |
|--|--|------------|
|  | Huile épaisse à viscosité élevée ou graisse<br>Dickflüssiges druckfestes Öl oder Fett<br>Thick, pressure-resistant oil or grease | Moebius D5 |
|  | Graisse/Fett/Grease  | Jismaa 124 |

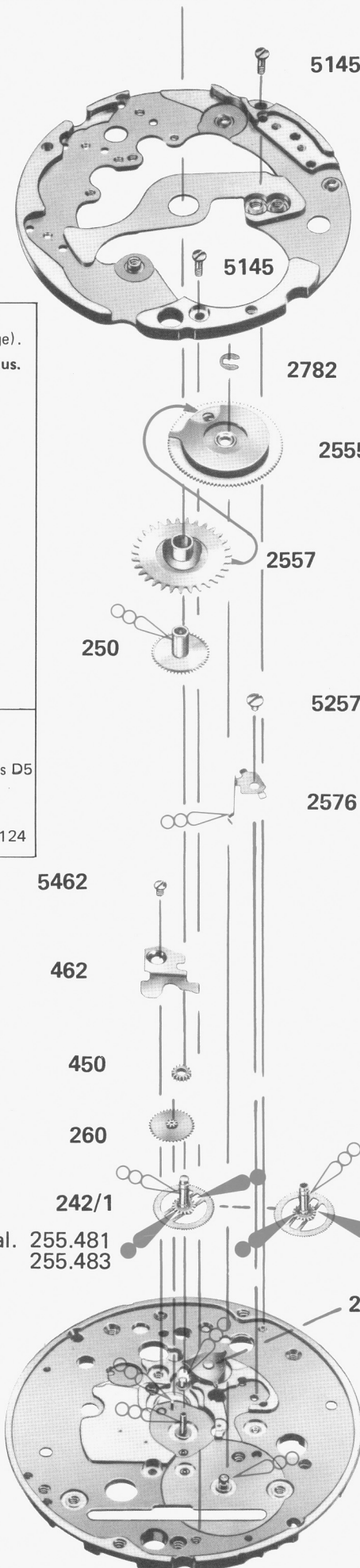

Cal.  
 Kal. 255.483 – 255.487  
 Cal.

**Montage du mécanisme de calendrier.**  
 (Liste des fournitures par ordre d'assemblage).

**Zusammenstellen des Kalender-Mechanismus.**  
 (Bestandteilliste in Montagerihenfolge).

**Assembling of the calendar-mechanism.**  
 (Parts listed in order of assembly).

2589	2578
52589 (2x)	52578 (1x)
2588	2549
52588 (1x)	52549 (1x)
2587/1	2561
52587 (1x)	2773
2577	(52562)
52577 (1x)	2562
	2808

 Huile épaisse à viscosité élevée ou graisse  
 Dickflüssiges druckfestes Öl oder Fett  
 Thick, pressure-resistant oil or grease  
 Moebius D5

