

CALIBRE – KALIBER – CALIBRE

2520

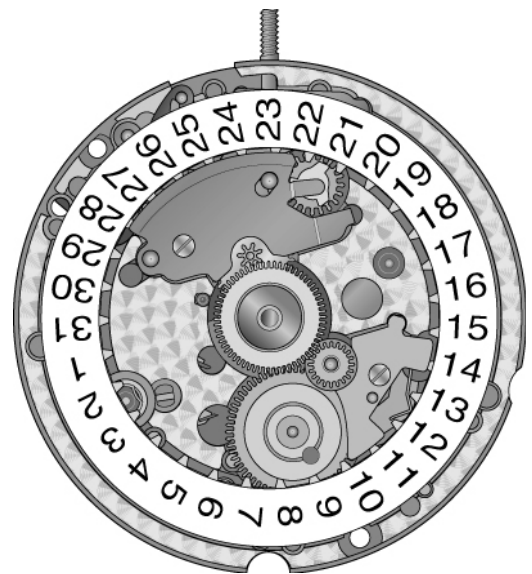

$8 \frac{3}{4}'''$ ø 19,40 mm	
HAUTEUR sur mouvement HÖHE auf Uhrwerk HEIGHT on movement	3,60 mm
Réserve de marche / Gangreserve / Power reserve Nombre de rubis / Anzahl Rubine / Number of jewels Fréquence / Frequenz / Frequency Angle de levée / Hebungswinkel der Unruh / Angle of lift	42 h 20 4 Hz (28'800 A/h) 50°

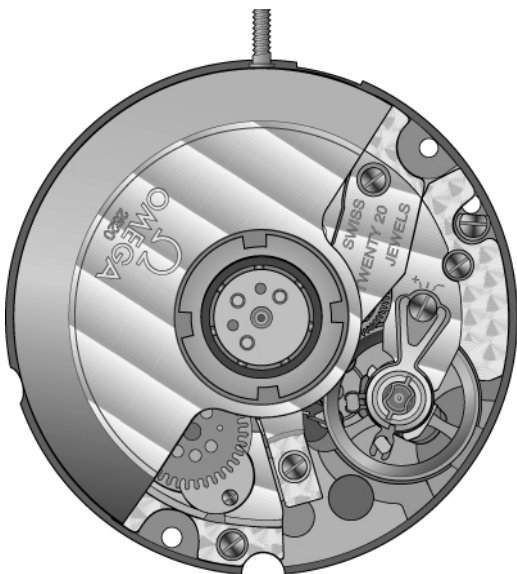

Liste des fournitures par ordre d'assemblage
Bestandteilliste in Montagerihenfolge)
Parts listed in order of assembly

100	450
161	453
407	2566
410	462
401	5462
2539	2557/1
443/1	2556
435/1	2543
445	2576
5445 (2x)	2595
242	52595
260	255/1

Lubrification – Schmierung – Lubrication

	Huile épaisse Dickflüssiges Öl Thick oil	Moebius D5
	Graisse Fett Grease	Moebius 9501

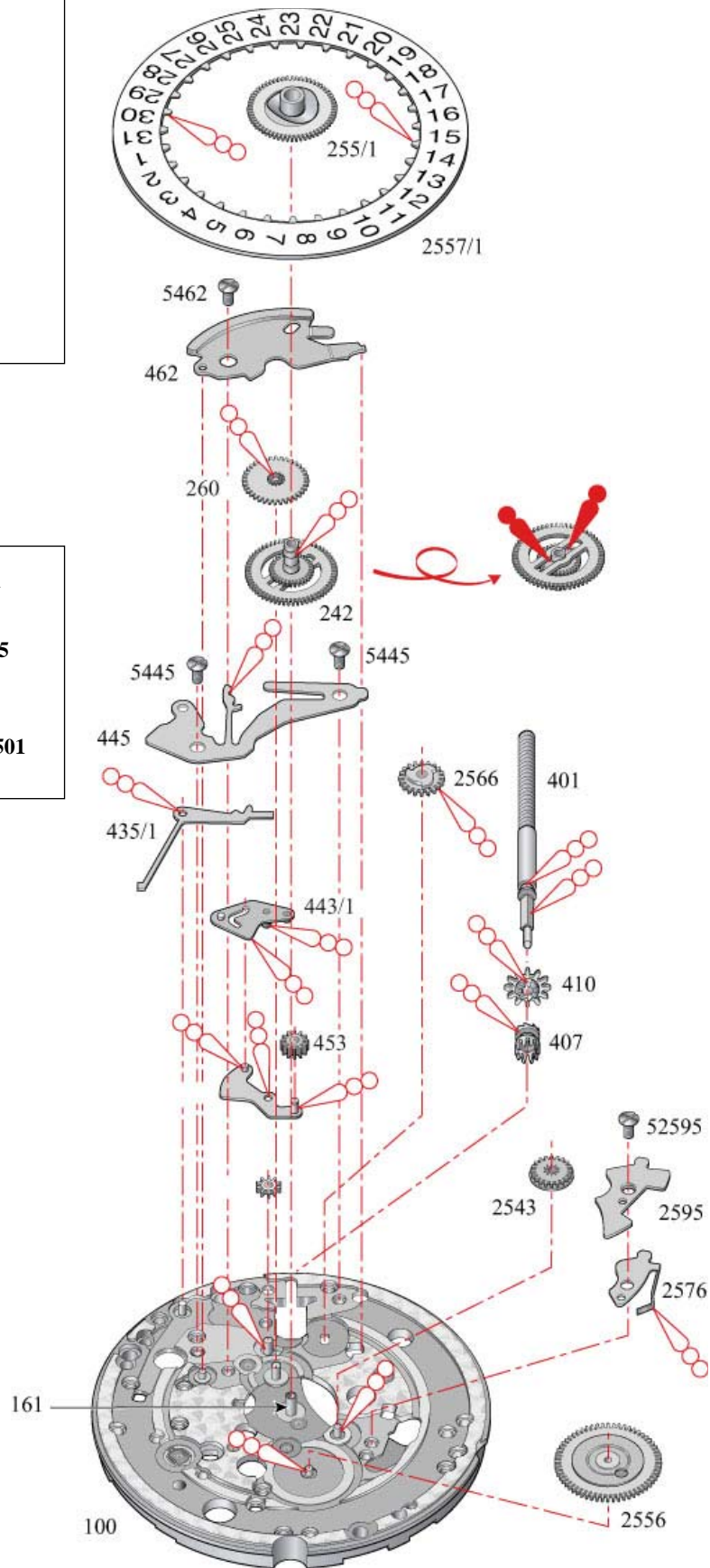

Liste des fournitures par ordre d'assemblage
Bestandteilliste in Montager Reihenfolge
Parts listed in order of assembly

3025	5110 (2x)
9433	710
203	125
180/1	5125 (2x)
415	358
105	375
5105 (2x)	303/15
705	3024
210	721
227	121/4
110	5121

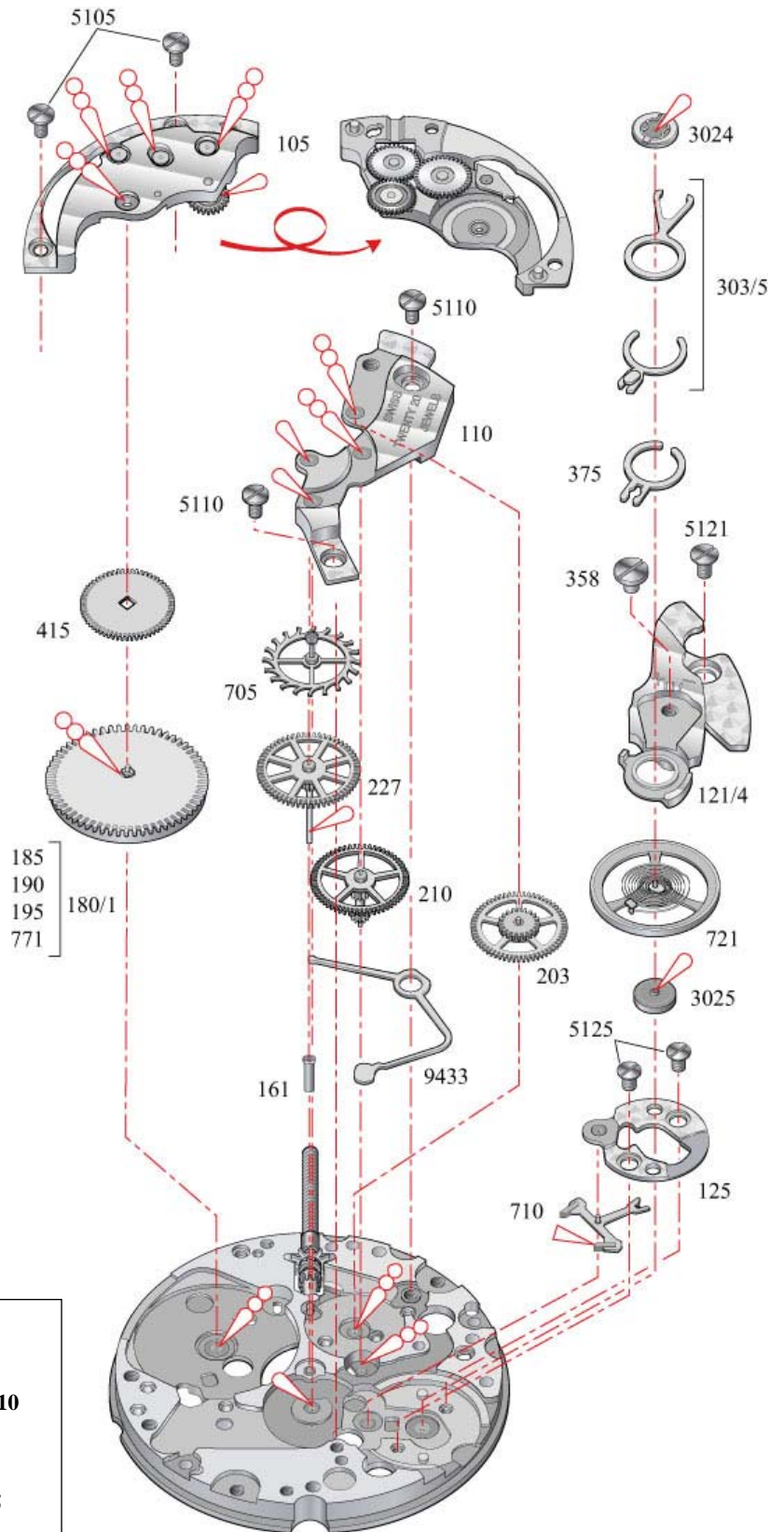

Lubrification – Schmierung – Lubrication

	Huile fine Dünnflüssiges Öl Fine oil	Moebius 9010
	Huile épaisse Dickflüssiges Öl Thick oil	Moebius D5
	Huile spéciale pour levées Spezial Öl für Hebungsteine Special oil for pallet stones	Moebius 9415

No 22.040: Seulement après lavage, très faible
lubrification avec Moebius 9010.
 Nr 22.040: Nur nach Waschen, sehr kleine Menge
mit Moebius 9010.
 No 22.040: Only after washing, use very little oil,
Moebius 9010.

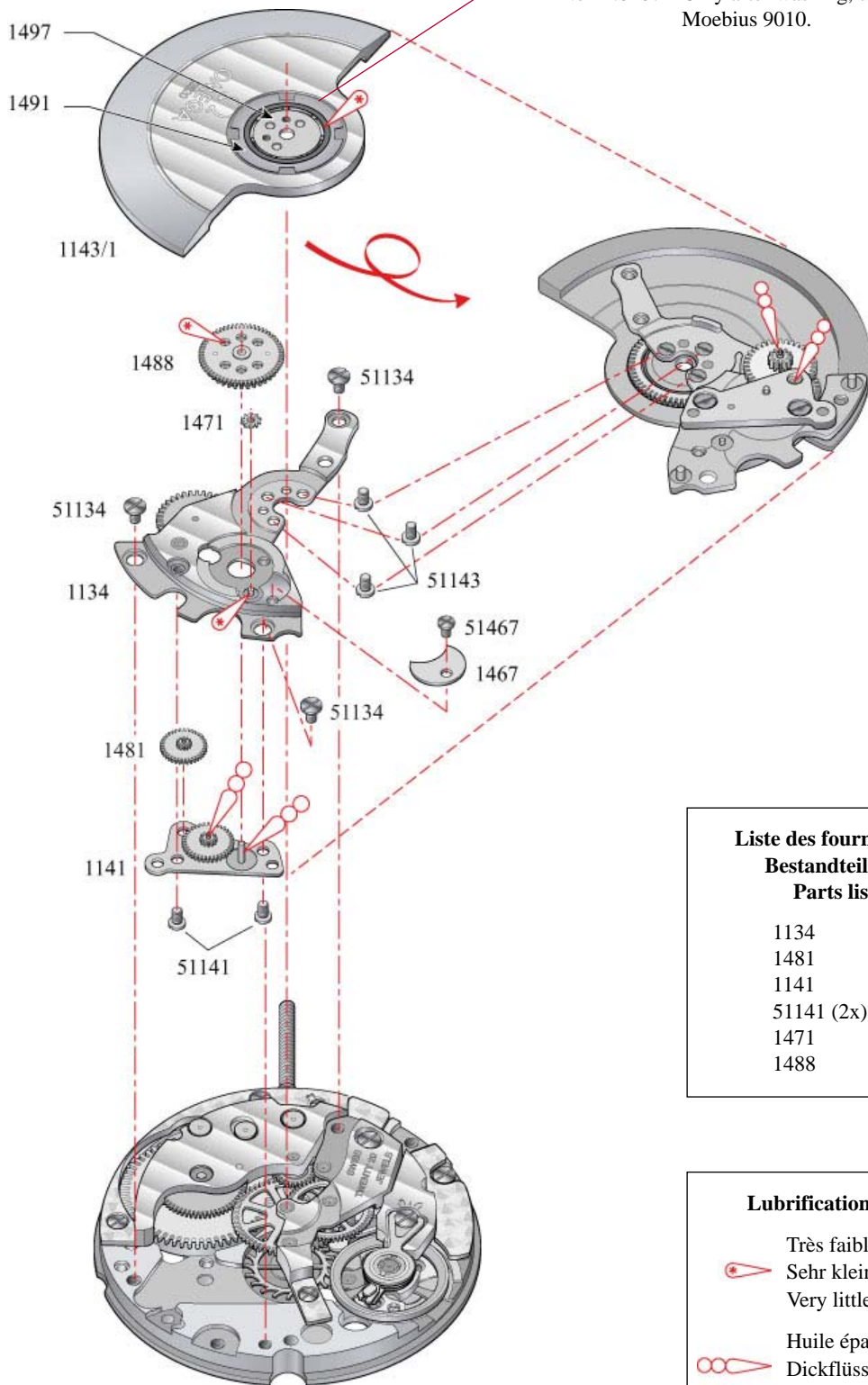

















































Liste des fournitures par ordre d'assemblage
Bestandteilliste in Montager Reihenfolge
Parts listed in order of assembly

1134	1467
1481	51467
1141	1143/1
51141 (2x)	51143 (3x)
1471	51134 (3x)
1488	

Lubrification – Schmierung – Lubrication

Très faible lubrification	
Sehr kleine Menge	Moebius 9010
Very little lubrication	
Huile épaisse	
Dickflüssiges Öl	Moebius D5
Thick oil	

Listes des fournitures – Bestandteilliste – Spare parts list

								5102				
100	105	110	121/4	125	144	161	182					
												5105 5110 5121 5125 51134
195	203	210	227	242	255/1	260	303/5	358	375	401	407	
												5445 5462 51141 51467 52595
410	415	435/1	443/1	445	450	453	462	705	710	721		
												51143
771	1134	1141	1143/1	1467	1471	1481	1488	2539				
												
2543	2556	2557/1	2566	2576	2595	3024	3025	9433				

Cal.	No SAV	No CS	Désignation	Bezeichnung	Designation
2520	100	10.020.07	Platine, empierrée	Werkplatte, mit Steinen	Main plate, jewelled
2520	105	10.041.07	Pont de barillet, empierré et monté	Federhausbrücke, mit Steinen, montiert	Barrel bridge, jewelled, assembled
725	110	10.048.07	Pont de rouage, empierré	Räderwerkbrücke, mit Steinen	Wheel train bridge, jewelled
725	121/4	10.058.24	Pont de balancier, pour raquette à flèche, amortisseur, porte-piton Etachron, correcteur	Unruhbrücke, für Rücker mit Stiel, Stossicherung, Spiralklötzchen-träger Etachron, Korrektor	Balance bridge, for regulator with pointer, shock-absorber, stud support Etachron, corrector
725	125	10.057.07	Pont d'ancre, empierré	Ankerbrücke, mit Steinen	Pallet bridge, jewelled
725	144	10.300	Fixateur de cadran	Zifferblatthalter	Dial fastener
725	161	80.400	Tube de centre	Zentrallagerrohr	Centre tube
2520	180/1	20.010	Barillet complet de mouvement	Federhaus vollständig für Grundwerk	Movement barrel complete
2520	182	20.030	Tambour et couvercle de barillet	Federhaustrommel und Deckel	Barrel drum and cover
725	195	20.060	Arbre de barillet	Federwelle	Barrel arbor
2520	203	30.012	Roue intermédiaire	Zwischenrad	Intermediate wheel
725	210	30.025	Roue moyenne	Kleinbodenrad	Third wheel
725	227	30.027	Roue de seconde	Sekundenrad	Second wheel
725	227/3	30.027.28	Roue de seconde, sans seconde au centre	Sekundenrad, ohne Zentralsekunde	Second wheel, without sweep second
725	242	31.083	Chaussée avec roue entraîneuse	Minutenrohr mit Mitnehmerrad	Cannon pinion with driving wheel
725	242/1	31.083.06	Chaussée avec roue entraîneuse, sans seconde au centre	Minutenrohr mit Mitnehmerrad, ohne Zentralsekunde	Cannon pinion with driving wheel, without sweep second
725	255/1	31.046.06	Roue des heures, montée	Stundenrad, montiert	Hour wheel, assembled
725	260	31.041	Roue de minuterie	Wechselrad	Minute wheel

Cal.	No SAV	No CS	Désignation	Bezeichnung	Designation
725	303/5	40.302.23	Raquette en 2 pièces, à flèche, pour porte-piton Etachron et correcteur	Rücker, zweiteilig, mit Stiel für Spiralklötzchenträger Etachron und Korrektor	Two-piece regulator, with pointer, for stud support Etachron and corrector
725	358	40.380	Correcteur de raquette	Rückerkorrektor	Regulator corrector
725	375	40.200	Porte-piton Etachron	Spiralklötzchenträger Etachron	Stud support Etachron
725	401	51.010.21	Tige de remontoir, diamètre de filetage 0,90 mm	Aufzugwelle, Gewindedurchmesser 0,90 mm	Winding stem, thread diameter 0.90 mm
725	407	31.121	Pignon coulant	Kupplungstrieb	Sliding pinion
725	410	31.120	Pignon de remontoir	Aufzugtrieb	Winding pinion
725	415	31.020	Rochet	Sperrad	Ratchet wheel
725	435/1	51.050	Bascule-ressort de pignon coulant	Kupplungstriebhebel mit Feder	Spring yoke
725	443/1	51.080.06	Tirette, montée	Winkelhebel, montiert	Setting lever, assembled
725	445	51.091	Sautoir de tirette	Winkelhebelraste	Setting lever jumper
725	450	31.100	Renvoi	Zeigerstellrad	Setting wheel
725	453	31.101	Renvoi intermédiaire	Zwischen-Zeigerstellrad	Intermediate setting wheel
725	462	10.062	Pont du rouage de minuterie	Wechselradbrücke	Minute train bridge
725	705	30.040	Roue d'échappement	Hemmungrad	Escape wheel
725	710	40.010	Ancre	Anker	Pallet fork
2520	721	40.050.21	Balancier annulaire, réglé, pour amortisseur et porte-piton Etachron	Unruh mit glattem Reif, reguliert, für Stossicherung und Spiralklötzchenträger Etachron	Timed annular balance, for shock-absorber and stud support Etachron
725	771	20.102	Ressort-moteur avec ressort de freinage	Triebfeder mit Schleppfeder	Mainspring with sliding attachment
725	1134	12.030.07	Bâti du dispositif automatique, empierré	Gestell für Automatik, mit Steinen	Automatic device framework, jewelled
725	1141	12.051.07	Pont inférieur du dispositif automatique empierré	Untere Brücke für Automatik, mit Steinen	Automatic device lower bridge, jewelled
2520	1143/1	22.010.06	Masse oscillante, montée	Schwungmasse, montiert	Oscillating weight, assembled
725	1467	12.123	Plaque de maintien de roue d'inversion	Halteplatte für Umkehrad	Reversing wheel maintaining plate
725	1481	32.081	Roue de réduction	Reduktionsrad	Reduction wheel
725	1488	32.037	Roue d'inversion	Umkehrad	Reversing wheel
725	1471	32.105	Pignon d'arrêt	Sperrtrieb	Stop pinion
725	2539	53.022	Commande correcteur de quantième	Schalthebel für Datumkorrektor	Date corrector operating lever
725	2543	33.011	Roue intermédiaire de quantième	Datum-Zwischenrad	Intermediate date wheel
725	2556	33.020	Roue entraîneuse de l'indicateur de quantième	Datumanzeiger-Mitnehmerrad	Date indicator driving wheel
* 725	2557/1	91.440	Indicateur de quantième, pour ouverture de guichet à 3 h	Datumanzeiger, für Fenster bei 3 Uhr	Date indicator, for window aperture at 3 o'clock
725	2566	53.200	Correcteur de quantième	Datumkorrektor	Date corrector
725	2576	53.080	Sautoir de quantième	Datumraste	Date jumper
725	2595	13.111	Plaque de maintien du sautoir de quantième	Halteplatte für Datumraste	Date jumper maintaining plate
725	9433	56.070	Levier stop	Stopphebel	Stop lever
725	3024	70.530	Amortisseur empierré, de balancier, dessus, à chasser, à portée	Stossicherung, mit Stein, für Unruh, oben, zum Einpressen, mit Auflage	Jewelled shock-absorber for balance, top, to press-in, shouldered
725	3025	70.531	Amortisseur empierré, de balancier, dessous, à chasser, cylindrique	Stossicherung, mit Stein, für Unruh, unten, zum Einpressen, zylindrisch	Jewelled shock-absorber for balance bottom, to press-in, cylindrical
725	5102	10.020.02	2x Vis de fixation, spéciale	Schraube für Werkbefestigung, Spezial-Ausführung	Case screw, special
1) 725	5105	10.041.01	2x Vis de pont de barillet	Schraube für Federhausbrücke	Screw for barrel bridge
1) 725	5110	10.048.01	2x Vis de pont de rouage	Schraube für Räderwerkbrücke	Screw for wheel train bridge
1) 725	5121	10.058.01	1x Vis de pont de balancier	Schraube für Unruhbrücke	Screw for balance bridge
1) 725	5125	10.057.01	2x Vis de pont d'ancre	Schraube für Ankerbrücke	Screw for pallet bridge
2) 725	5445	51.091.01	2x Vis de sautoir de tirette combiné	Schraube für kombinierte Winkelhebelraste	Screw for combined setting lever jumper
1) 725	5462	10.062.01	1x Vis de pont du rouage de minuterie	Schraube für Wechselradbrücke	Screw for minute train bridge
2) 725	51134	12.030.01	3x Vis de bâti du dispositif automatique	Schraube für Gestell für Automatik	Screw for automatic device framework
2) 725	51141	12.051.01	2x Vis de pont inférieur du dispositif automatique	Schraube für untere Brücke für Automatik	Screw for automatic device lower bridge
725	51143	22.010.01	3x Vis de masse oscillante	Schraube für Schwungmasse	Screw for oscillating weight
2) 725	51467	12.123.01	1x Vis de plaque de maintien de rous d'inversion	Schraube für Halteplatte für Umkehrad	Screw for reversing wheel maintaining plate
2) 725	52595	13.111.01	1x Vis de plaque de maintien du sautoir de quantième	Schraube für Halteplatte für Datumraste	Screw for date jumper maintaining plate

1) 2) Vis identiques/Identische Schrauben/Identical screws

* Plusieurs versions disponibles/Verschiedene Versionen erhältlich/Several versions available